



• IR-CAST 2C+

700°C to 1700°C

Features

- Rectangular field of view for molten metal.
- Wide temperature ranges from 700°C to 1700°C.
- Focusable Optics
- Spectral range 0.7 μm1.15 μm
- Fast response time within milliseconds
- Integrated OLED display and parameterizing keys
- Through the lens view finder and Video module sighting options
- Analog output options available like 0...20mA, 4...20mA
- Relay Output
- RS-485 Serial interface
- User friendly PC software for communication
- Green LED for pyrometer status indication
- Red LED for Laser ON/OFF indication (PL)

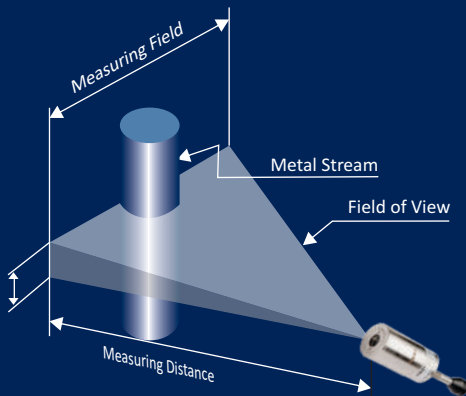

Standard Scope of Supply

- Pyrometer with Focusable optics, OLED Display & Parameterizing Keys
- Through the lens(TL) sighting / Video module (user can select while ordering)
- Analog output 4...20mA, 0..20mA
- Digital Interface RS-485
- 5 mtr long connection cable with connector
- Calibration certificate, Software & Operation manual

Applications

- Molten Metal

Optional

- Mechanical & Electrical Accessories
- Extra Cable Lengths

• IR-CAST 2C+

Highly Accurate Focusable Two Color Online Infrared Non-Contact Pyrometer with Rectangular FOV for Casting Application



IR-CAST 2C+ is a highly accurate focusable digital two colour Rectangular measuring field IR pyrometer for non contact temperature measurement specially used in foundries for molten metal. The Pyrometer measures the temperature of an object by calculating the ratio of the energies at two different wavelength bands. The ratio technique eliminates and reduces errors in temperature measurement caused by factors such as dust, vapour or smoke etc.

If the target is within this rectangular area, it gives an accurate temperature reading even when liquid moves within this area.

The IR pyrometer parameters can be selected via the keypad on the back panel. The settings are displayed on the OLED Display. In the measuring mode real time temperature is displayed. In Pyrometers with video module real time colour video, measuring temperature and emissivity is displayed on the television screen. IR Cast 2C+ has focusable optics for optimal match of the instrument for various applications. The pyrometer is equipped with RS-485; analog outputs 0/4....20mA. Switching laser ON/OFF does not effect the measurement.

Software “Infrasoft”

AST “Infrasoft” software is under standard scope of supply. It offers possibilities of connecting three pyrometers simultaneously for parameter setting, view real time graph, offline graph and to evaluate measuring data. Communication between the pyrometer and the software is implemented via a cable connected between the pyrometer and the PC serial port. It comes with record feature, spot size calculator and parameter settings features.

Some of the parameters adjustable via software are

- Emissivity, Response Time
- Clear Time(Peak Picker)
- Analog Output
- Sub Range
- Unit of Temperature(°C/°F)
- Communication mode(Comm.mode)

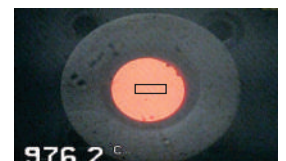
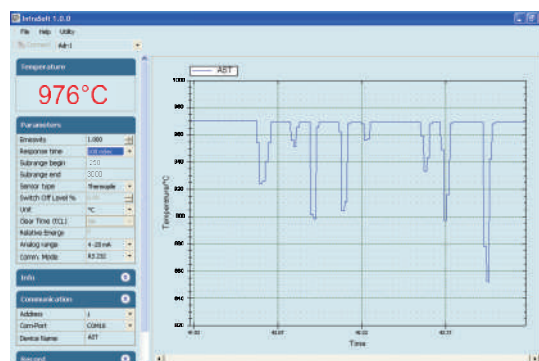
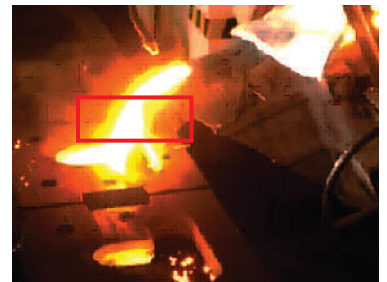







Example Video Image

Technical Specifications

| | |
|--|---|
| Model | IR-CAST 2C+ |
| Temperature Range (Analog sub-range adjustable) | 700°C....1700°C |
| Spectral Range | 0.7....1.15 μm |
| Photodetector Type | Si/Si |
| Distance to Spot Size Ratio | D _v = 250:1 (V = Vertical) D _h = 50:1 (H = Horizontal) |
| Emissivity (ε) | 0.1....1.0 adjustable (Single color mode) |
| Emissivity Slope (ε1 / ε2) | 0.75...1.25 slope adjustable (Two color mode) |
| Response Time | 20 msec adjustable upto 10 sec |
| Accuracy | ± 0.5% of the measured value + 1°C |
| Repeatability | 0.1% of reading in °C + 1°C |
| Sighting Options | Through The Lens (TL)/Video module |
| Analog Output | 0-20mA, 4-20mA (User selectable) |
| Digital Output | RS-485 |
| Operating Temp. Range | 0°C.....70°C 0°C.....200°C (With water cooling jacket) |
| Storage Temp. Range | -20°C...70°C |
| Adjustable Parameters and Features via software | Emissivity, Emissivity Slope, Response Time, Clear Time(Peak Picker), Analog Output, Analog Scale(Sub range),Sensor type (Switches b\w 2-color or single color), Switch off level, Unit Of Temperature(°C/°F), Communication mode(Comm.mode), Record feature etc |
| Power Supply | 12V DC to 28V DC with reverse voltage protection |
| Power Consumption | Max 4.0 watt |
| Relay Output | One relay output with hysteresis 60V DC/42V AC RMS 0.4A |
| Protection Class | IP65 |
| Housing | Stainless Steel |
| Isolation | Power supply,*Digital output and Analog output are galvanically islolated against each other |
| Operating Humidity | 10-95%, Non-Condensing Conditions |
| Weight & Dimensions | 1200g Dia= Ø56 mm; Length=188.5mm |

Spot Sizes

| Focused Working Distances WD (mm) | Spot Sizes (mm) | | |
|-----------------------------------|-----------------|-----------|---|
| | 700° - 1700°C | | Measuring Field |
| | FOVV 250:1 | FOVH 50:1 | |
| 500 | 2 | 10 |  |
| 750 | 3 | 15 |  |
| 1000 | 4 | 20 |  |
| 2000 | 8 | 40 |  |
| 3000 | 12 | 60 |  |
| 5000 | 20 | 100 |  |
| 9000 | 36 | 180 |  |

Pyrometer Drawings

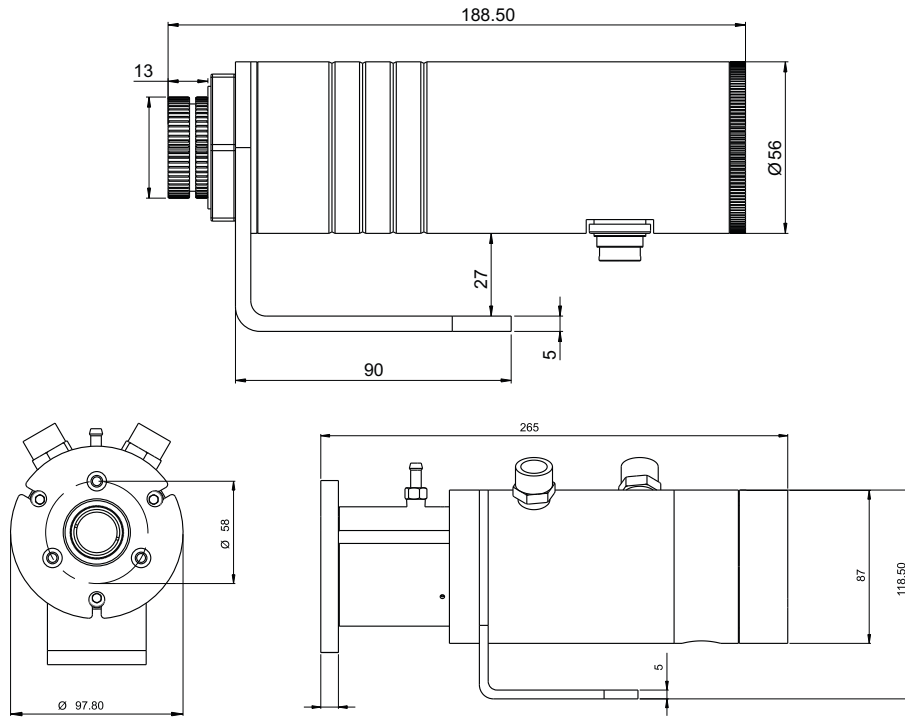

Accessories

Mounting Clamp (Pyrometer)
(Reference no: 8500-04)



Air Purge
(Reference no: 8500-05)



Mounting Clamp (Water Cooling Jacket)
(Reference no: 8500-06)



Mounting Flange
(Reference no: 8500-07)



Mounting Plate
(Reference no: 8500-08)



Water Cooling Jacket
(Reference no: 8500-09)



Temperature Indicator
(Reference no: 9000-01)



Adjustable Mounting Stand
(Reference no: 8000-07)

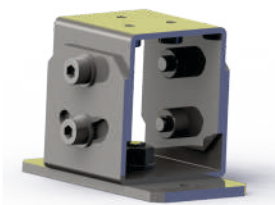

Power supply Input 110/230V AC
Reference No. 9000 - 02
Output 24 V DC, 0.7Amp.



Assembly Options

Pyrometer with Mounting Clamp (8500-04)



Pyrometer with Mounting Flange (8500-07) + Air Purge (8500-05) + Water Cooling Jacket (8500-09)

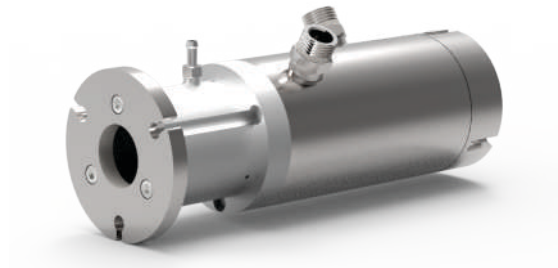

Pyrometer with Air Purge (8500-05) + Mounting Clamp (8500-06)

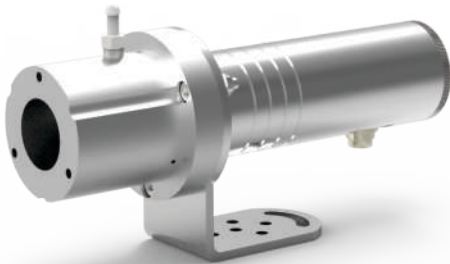

Pyrometer with Water Cooling Jacket (8500-09) + Mounting Clamp (8500-06)



Pyrometer with Mounting Flange (8500-07) + Air Purge (8500-05)

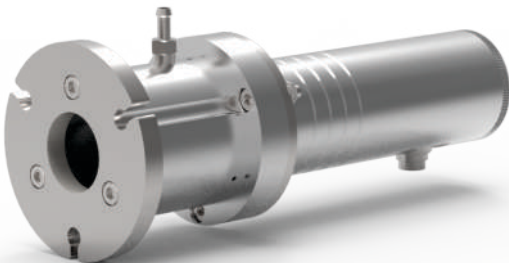

Pyrometer with Mounting Flange (8500-07) + Air Purge (8500-05) + Water Cooling Jacket (8500-09)



Accurate Sensing Technologies Pvt. Ltd.

B-188, B-189, B-169(Part), B-188A & F-188E, Road No. - 5,
Mewar Industrial Area(M. I. A.), Madri, Udaipur-313003,
(Rajasthan) INDIA

Phone : +91-9352506032

Email : info@pyrosens.com

